

Excellent
Watersport



Benzine-onderdelen

Carburateurs
Benzinepompen

Benzinefilters
Connectoren

INHOUD

1	CARBURATEURS	4
2	CARBURATEURREVISIESETS	10
3	CARBURATEURREVISIESETS BINNENBOORDMOTOREN	22
4	BENZINEPOMPEN	26
5	REVISIESETS BENZINEPOMPEN	29
6	ELECTRISCHE BENZINEPOMPEN	32
7	MERCUISE INJECTOREN	40
8	BRANDSTOFFILTERS	42
9	BENZINECONNECTOREN MOTOR EN TANK	46

DISCLAIMER

De informatie die in deze catalogus wordt geboden is onder voorbehoud, hierbij inbegrepen de specificaties van producten. De getoonde afbeeldingen worden slechts ter illustratie gebruikt en kunnen afwijken van de aangeduide producten. Op al onze offertes en overeenkomsten zijn onze leveringsvoorwaarden van toepassing. Op alle producten 1 jaar fabrieksgarantie tegen fabricagefouten.

PROBLEMEN MET BRANDSTOFSYSTEMEN? EXCELLENT WATERSPORT HEEFT DE OPLOSSING!



Geachte relatie,

Het 'milieuvriendelijker' maken van benzine door het toevoegen van bijvoorbeeld ethanol veroorzaakt veel problemen aan het brandstofsysteem van binnen- en buitenboordmotoren. Excellent Watersport heeft daarom haar assortiment uitgebreid met producten en onderdelen voor brandstofsysteem.

Ethanol heeft niet alleen de vervelende eigenschap dat het ervoor zorgt dat de benzine snel verouderd, maar deze stof trekt ook nog eens water aan. Water, daar lopen motoren over het algemeen niet zo goed op! Het zorgt er bovendien voor dat de materialen in het brandstofsysteem zoals carburateurs of injectiesystemen worden aangetast. Daardoor raakt het benzine-lucht mengsel ontregeld en gaat de motor slechter lopen.

Speciaal hiervoor biedt Excellent in deze mini-catalogus onderdelen en producten aan die frequent vervangen moeten worden door de gewijzigde samenstelling van de benzine. Zo vindt u hier carburateurs, revisiesets voor carburateurs, benzinepompen, benzinefilters, elektrische benzinepompen, connectoren en injectoren voor motoren met benzine-inspuiting.

Deze catalogus is aanvulling op de hoofdcatalogus van Excellent Watersport. Mocht u vragen hebben over de producten uit deze serie, wilt u iets weten over andere producten of heeft u nog geen exemplaar van de uitgebreide Excellent Watersport catalogus? Bel ons gerust op (0297) 250 219. We staan u graag te woord!

Met vriendelijke groet,
Excellent Watersport

Rick van Rietbergen



Communicatieweg 9-2
3641 SG Mijdrecht

tel 0297 250 219
fax 0297 256 897

www.excellentwatersport.nl

Carburateurs voor Yamaha 2 takt buitenboordmotoren



Artikel	Motor	Bouwjaar	Origineel onderdeel nummer
100101	Yamaha M2B	'85-'05	6A1-14301-03, 6F8-14301-03

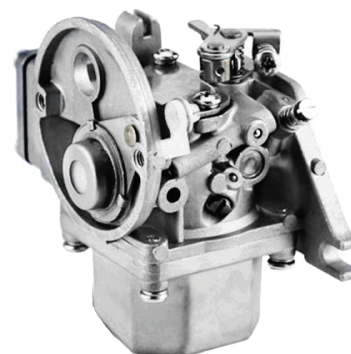

Artikel	Motor	Bouwjaar	Origineel onderdeel nummer
100102	Yamaha M4AS, M5CS	'86-'15	6E3-14301-05, 6E0-14301-05

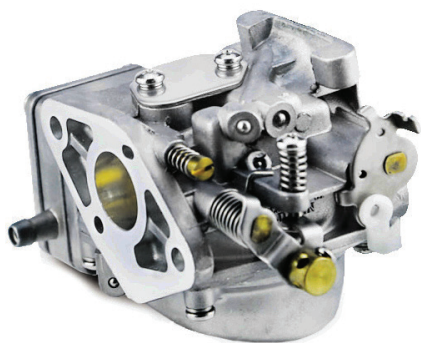

Artikel	Motor	Bouwjaar	Origineel onderdeel nummer
100104	Yamaha M6, M8	'84-'03	6G1-14301-01
100104	Yamaha M6, M8	'04-'06	6N0-14301-10

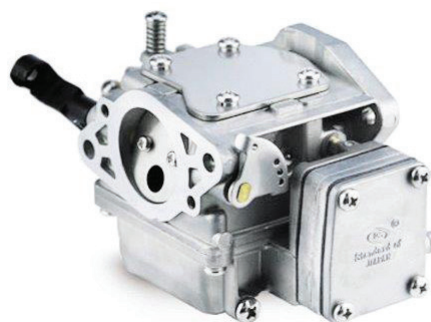

Artikel	Motor	Bouwjaar	Origineel onderdeel nummer
100109	Yamaha M9.9, M15	D Serie	6B4-14301-00
100109	Parsun M 9.8, M15	D Serie	



Artikel	Motor	Bouwjaar	Origineel onderdeel nummer
100108	Yamaha M9.9, M15	'84-'95	684-14301-04, 6E7-14301-04

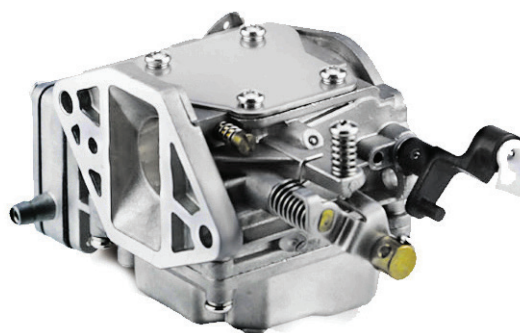

Artikel	Motor	Bouwjaar	Origineel onderdeel nummer
100111	Yamaha M9.9, M15	F Serie	63V-14301-00

■ 2 Takt
 ■ 4 Takt
 ■ Inboard

- Vervolg - Carburateurs voor Yamaha 2 takt buitenboordmotoren



Artikel	Motor	Bouwjaar	Origineel onderdeel nummer
100112	Yamaha M25B, M30H	Vanaf 1996	69S-14301-00, 69P-14301-00
100112	Parsun, Hidea etc. M25, M30	Vanaf 1996	



Artikel	Motor	Bouwjaar	Origineel onderdeel nummer
100113	Yamaha M25, M30	'93-'96	61N-14301-00

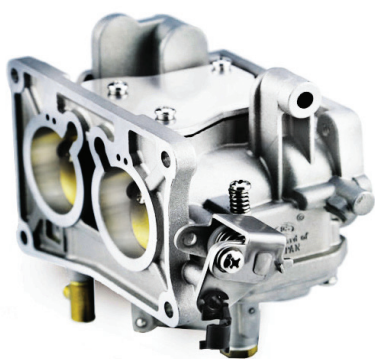

Artikel	Motor	Bouwjaar	Origineel onderdeel nummer
100114	Yamaha M40	'86-'93	6F6-14301-05, 6J4-14301-05

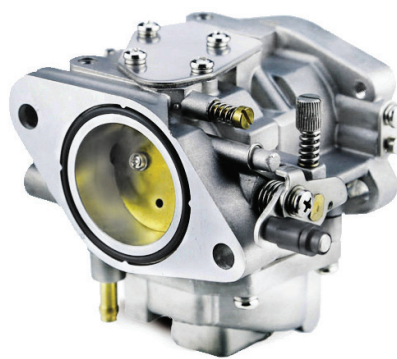

Artikel	Motor	Bouwjaar	Origineel onderdeel nummer
100115	Yamaha M30, M40	'06-'12	66T-14301-02

Carburateurs voor Yamaha 4 takt buitenboordmotoren

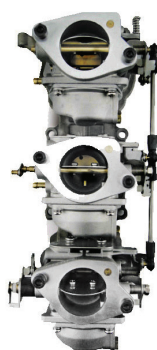

Artikel	Motor	Bouwjaar	Origineel onderdeel nummer
100116	Yamaha M60	'95-'00	6K5-14301-1,2,3



Artikel	Motor	Bouwjaar	Origineel onderdeel nummer
100201	Yamaha F2.5	Vanaf '03	69M-14301-00

■ 2 Takt
 ■ 4 Takt
 ■ Inboard

- Vervolg - Carburateurs voor Yamaha 4 takt buitenboordmotoren



Artikel	Motor	Bouwjaar	Origineel onderdeel nummer
100202	Yamaha F4	'00-'03	67D-14301-03



Artikel	Motor	Bouwjaar	Origineel onderdeel nummer
100203	Yamaha F4	Vanaf '04	68D-14301-11



Artikel	Motor	Bouwjaar	Origineel onderdeel nummer
100205	Yamaha F6	Vanaf '06	6BX-14301-11



Artikel	Motor	Bouwjaar	Origineel onderdeel nummer
100206	Yamaha F6, F8, F9.9	'01-'06	68T-14301-11



Artikel	Motor	Bouwjaar	Origineel onderdeel nummer
100207	Yamaha F15	'98-'06	66M-14301-12



Artikel	Motor	Bouwjaar	Origineel onderdeel nummer
100208	Yamaha F20	vanaf '06	6AH-14301-00
100208	Parsun, Hidea F20	Vanaf '06	

■ 2 Takt
 ■ 4 Takt
 ■ Inboard

- Vervolg - Carburateurs voor Yamaha 4 takt buitenboordmotoren



Artikel	Motor	Bouwjaar	Origineel onderdeel nummer
100209	Yamaha F25	'98-'03	65W-14901-12
100209	Parsun, Hidea F25	'98-'03	

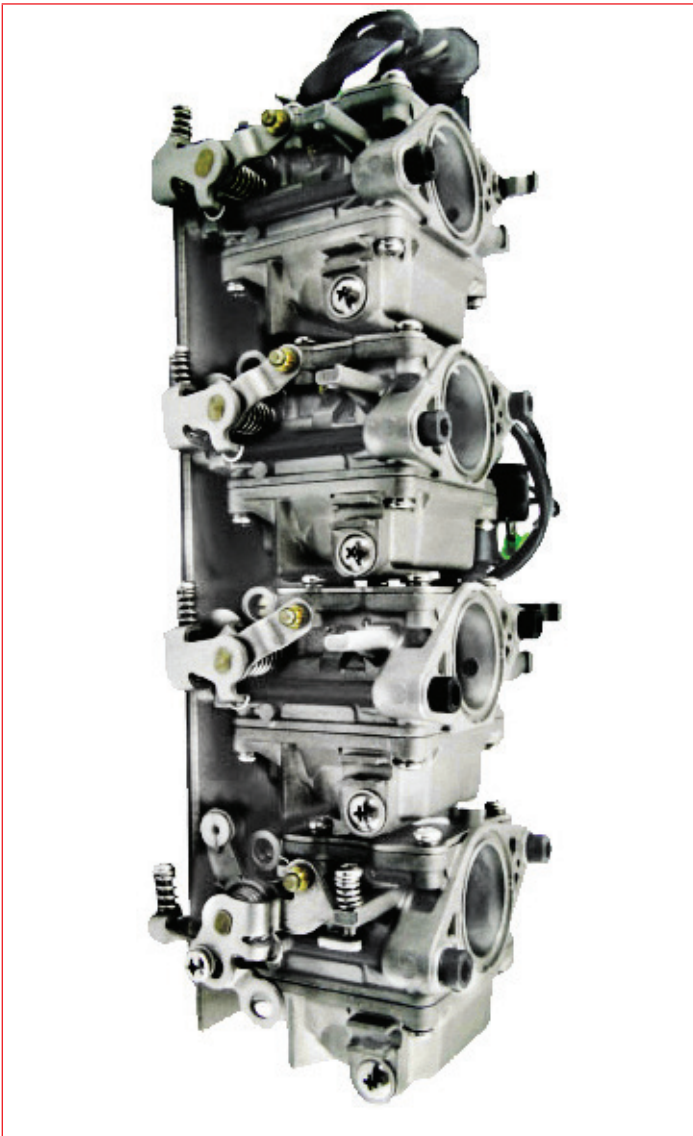

Artikel	Motor	Bouwjaar	Origineel onderdeel nummer
100210	Yamaha F50	vanaf '03	62Y-14901,2,3,4-00

2 Takt
4 Takt
Inboard

Carburateurs voor Mercury 2 takt buitenboordmotoren



Artikel	Motor	Bouwjaar	Origineel onderdeel nummer
100100	Mercury 2.5, 3.5		3303-815070, 3303-823040A4

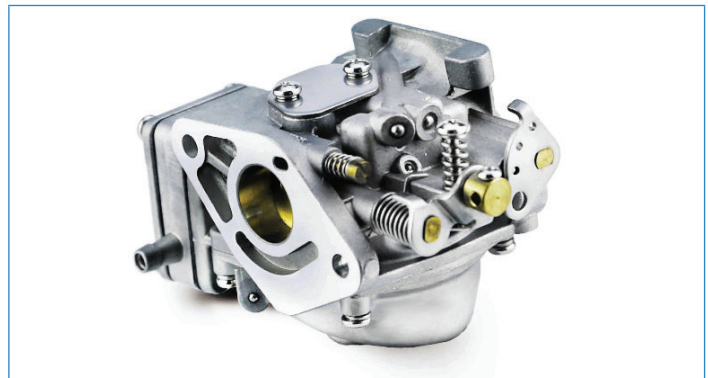

Artikel	Motor	Bouwjaar	Origineel onderdeel nummer
100103	Mercury M4, M5	vanaf '98	812647T1, 812648T



Artikel	Motor	Bouwjaar	Origineel onderdeel nummer
100117	Mercury 75-90	'85-'95	3301-9012, 3301-9013

Carburateurs voor Mercury 4 takt buitenboordmotoren

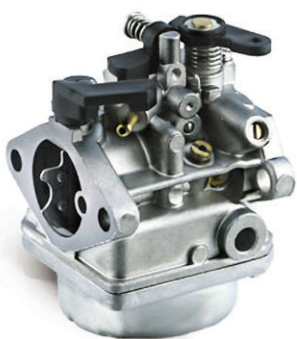

Artikel	Motor	Bouwjaar	Origineel onderdeel nummer
100204	Mercury F4, F5	'00 - '16	3303-879659A1



Artikel	Motor	Bouwjaar	Origineel onderdeel nummer
100207	Mercury 15	'07-'16	3303-853720

Carburateurs voor Tohatsu 2 takt buitenboordmotoren



Artikel	Motor	Bouwjaar	Origineel onderdeel nummer
100100	Tohatsu M3.5A2,	Tot '05	3D5-03100-0
100100	Tohatsu M3.5B2		3F0-03100-0

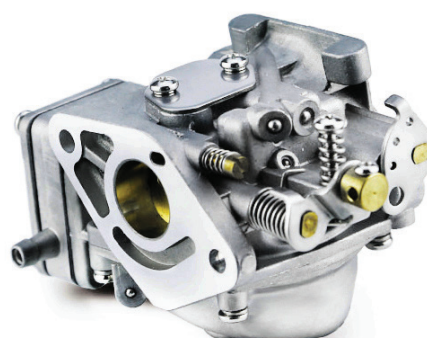

Artikel	Motor	Bouwjaar	Origineel onderdeel nummer
100103	Tohatsu M4B, M5A	'96 -'02	369-03200-2

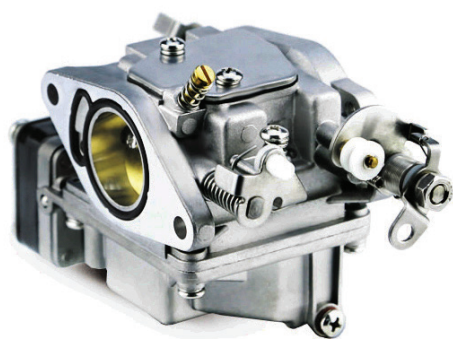

Artikel	Motor	Bouwjaar	Origineel onderdeel nummer
100107	Tohatsu M9.9	vanaf '96	3G2-03100-0
100107	Tohatsu M15 , M18	vanaf '96	3G2-03100-2

■ 2 Takt
 ■ 4 Takt
 ■ Inboard

Carburateurs voor Tohatsu 4 takt buitenboordmotoren



Artikel	Motor	Bouwjaar	Origineel onderdeel nummer
100204	Tohatsu F4, F5		3R1-03200-0, 3R4-03200-0



Artikel	Motor	Bouwjaar	Origineel onderdeel nummer
100206	Tohatsu MF9.8A	tot '17	3DP-03133-0

Carburateurs voor Suzuki 2 takt buitenboordmotoren



Artikel	Motor	Bouwjaar	Origineel onderdeel nummer
100207	Tohatsu F15C	vanaf '07	3BH-03100-0



Artikel	Motor	Bouwjaar	Origineel onderdeel nummer
100106	Suzuki M9.9	vanaf '83	13200-91D21
100106	Suzuki M15	vanaf '83	13200-839D1

Carburateurs voor Honda 4 takt buitenboordmotoren



Artikel	Motor	Bouwjaar	Origineel onderdeel nummer
100200	Honda 2.3 PK	vanaf '99	16100-ZW6-716

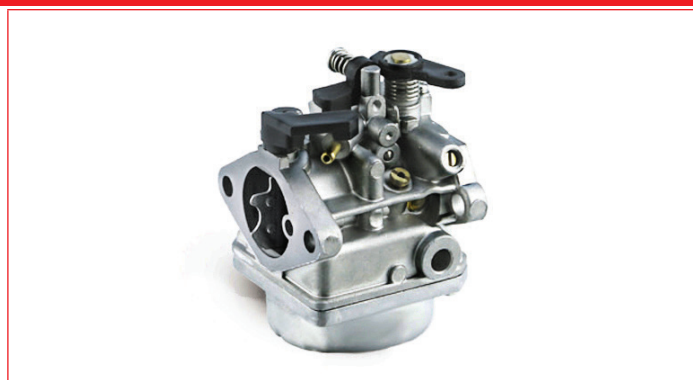

Artikel	Motor	Bouwjaar	Origineel onderdeel nummer
100204	Honda F5		16100-ZV1-A03

■ 2 Takt
 ■ 4 Takt
 ■ Inboard

Carburateurrevisiesets voor Johnson / Evinrude

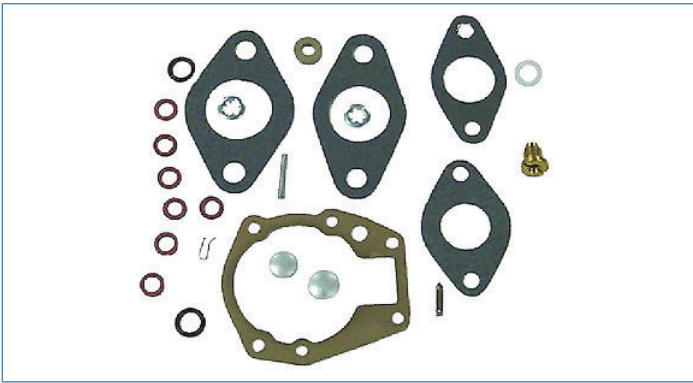

Artikel	Motor	Bouwjaar	Origineel onderdeel nummer
100526	1.5.....20 PK	57-'78	439071



Artikel	Motor	Bouwjaar	Origineel onderdeel nummer
100531	F25, F30 PK	00-'01	5032424



Artikel	Motor	Bouwjaar	Origineel onderdeel nummer
100533	F4, F6	07	Geen OEM nummer bekend

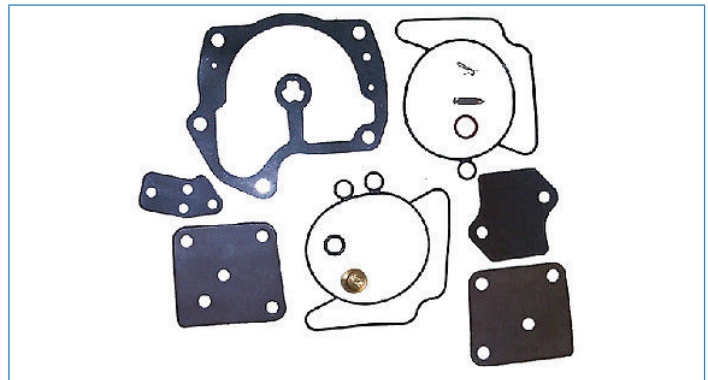

Artikel	Motor	Bouwjaar	Origineel onderdeel nummer
100537	120, 125, 140, 250, 300 PK	85-'93	439079

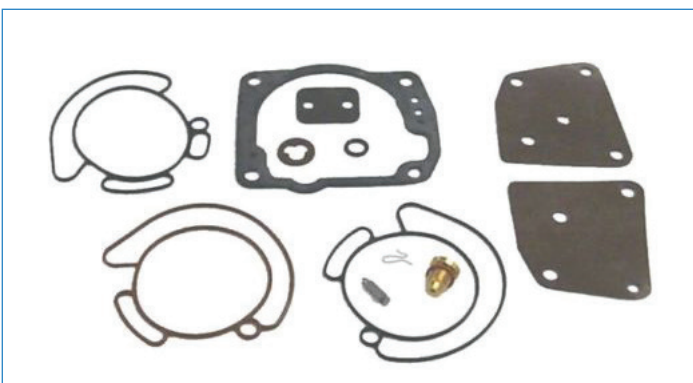

Artikel	Motor	Bouwjaar	Origineel onderdeel nummer
100539	V4 & V6 motoren 60°	88-'01	438996



Artikel	Motor	Bouwjaar	Origineel onderdeel nummer
100541	5, 6, 25, 30, 35, 40	54-'78	439075 / 385356

■ 2 Takt
 ■ 4 Takt
 ■ Inboard

- Vervolg - Carburateurrevisiesets voor Johnson / Evinrude



Artikel	Motor	Bouwjaar	Origineel onderdeel nummer
100542	6, 8, 9.9, 15, 20	86-'98	439073



Artikel	Motor	Bouwjaar	Origineel onderdeel nummer
100543	4, 4.5, 5, 6, 7.5, 8	74-'89	398453

Carburateurrevisiesets voor Honda

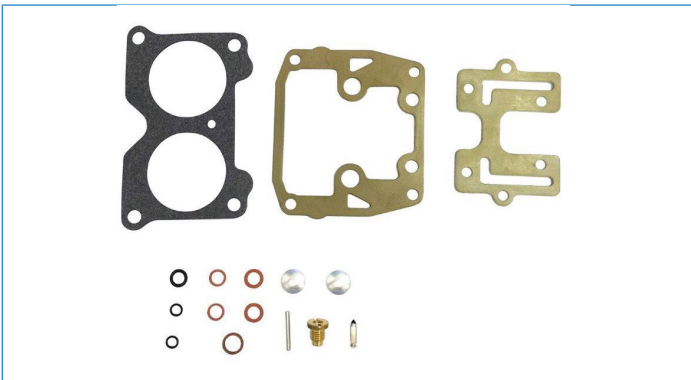

Artikel	Motor	Bouwjaar	Origineel onderdeel nummer
100544	85, 115, 125, 135, ...185	76-'95	390055, 392550, 439076



Artikel	Motor	Bouwjaar	Origineel onderdeel nummer
100530	BF 9.9 & BF 15 PK	v.a.'01	Geen OEM Nummer

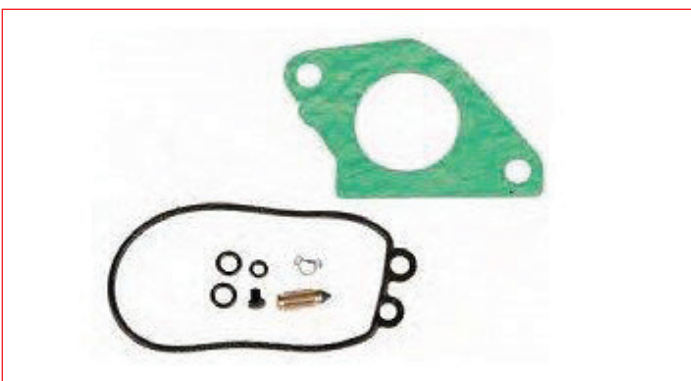

Artikel	Motor	Bouwjaar	Origineel onderdeel nummer
100529	BF75 & BF 90	v.a.'97	16011-ZV4-005



Artikel	Motor	Bouwjaar	Origineel onderdeel nummer
100501	2.5, 3.5 PK	82-'88	92520M

■ 2 Takt
 ■ 4 Takt
 ■ Inboard

Carburateurrevisiesets Mercury / Mariner

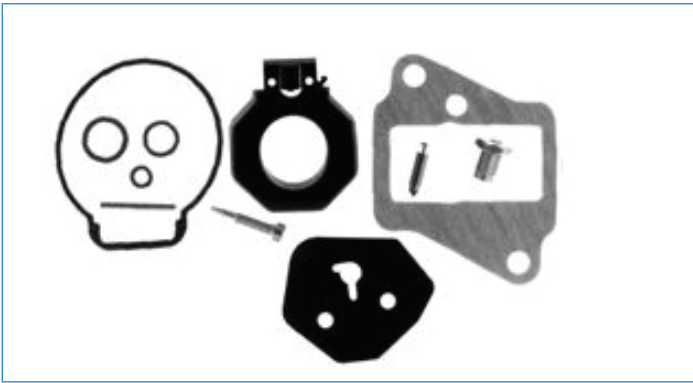

Artikel	Motor	Bouwjaar	Origineel onderdeel nummer
100504	9.9, 15 PK (Alleen Mariner)	79-'86	814481M

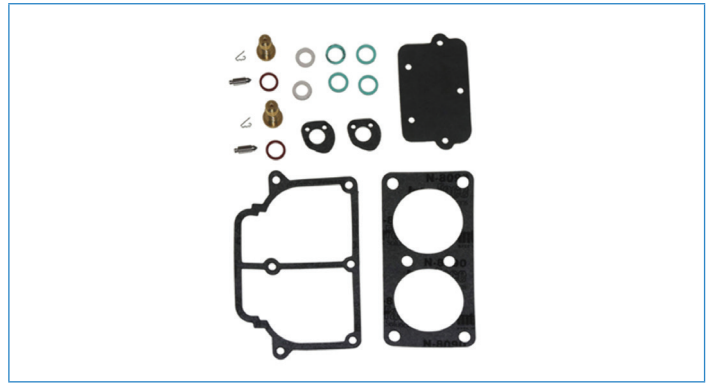

Artikel	Motor	Bouwjaar	Origineel onderdeel nummer
100508	135, 150, XR2, 175, 200, 225 PK	78-'90	1395-6452



Artikel	Motor	Bouwjaar	Origineel onderdeel nummer
100554	6, 8, 9.9, 15, 18, 20, 25 PK 2 cilinders		1395-9761-1

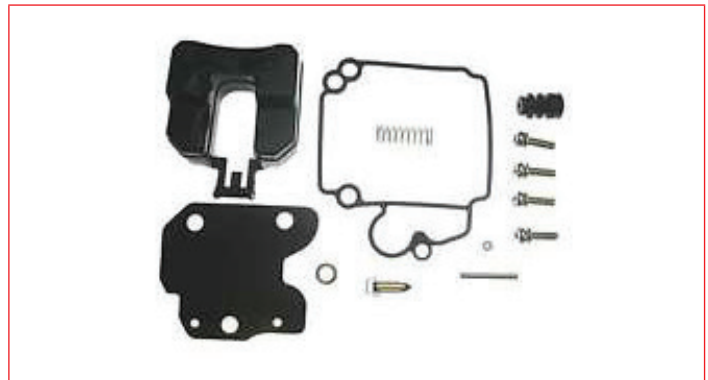

Artikel	Motor	Bouwjaar	Origineel onderdeel nummer
100512	F25, F30, F40, F50, F60 PK	98-'02	854256



Artikel	Motor	Bouwjaar	Origineel onderdeel nummer
100517	F2.5, F3.5	v.a.'07	898103A68

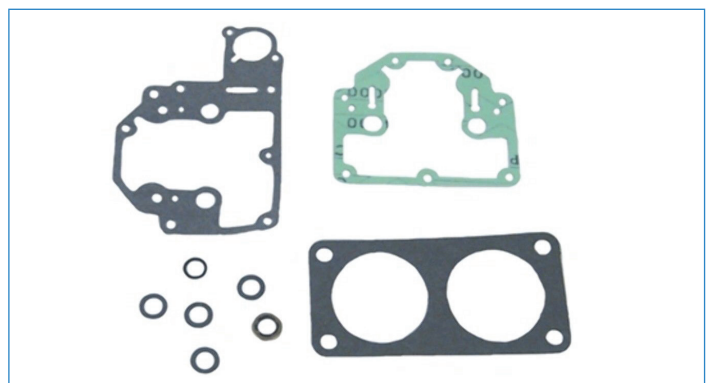

Artikel	Motor	Bouwjaar	Origineel onderdeel nummer
100518	135, 150, 175, 200, 225	91-'95	810749-2

■ 2 Takt
 ■ 4 Takt
 ■ Inboard

- Vervolg - Carburateurrevisiesets Mercury / Mariner

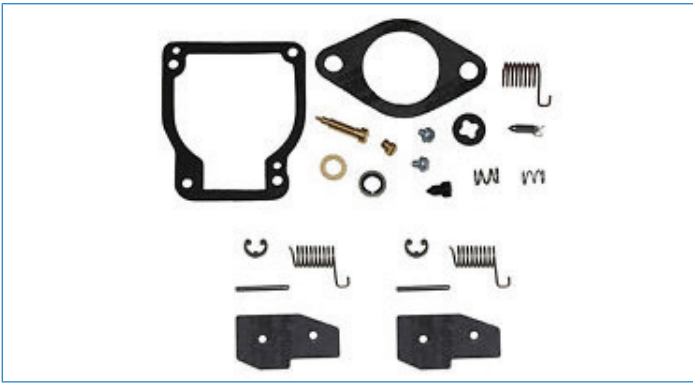

Artikel	Motor	Bouwjaar	Origineel onderdeel nummer
100520	30,35,40,45..... 120 PK	70-'85	1395-8236354



Artikel	Motor	Bouwjaar	Origineel onderdeel nummer
100525	25, 30 PK Mariner	84-'97	823707

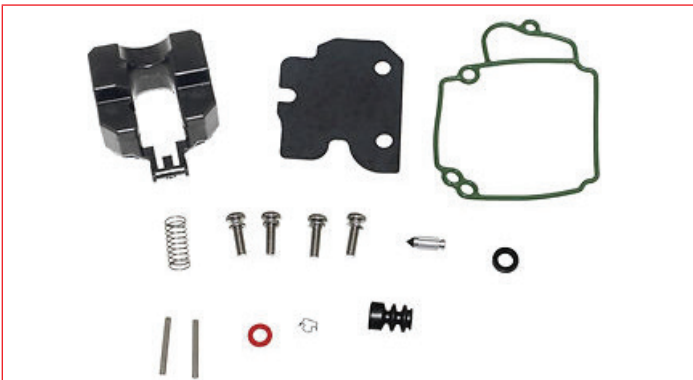

Artikel	Motor	Bouwjaar	Origineel onderdeel nummer
100513	Mercury F25-F60	98-'02	854256-1

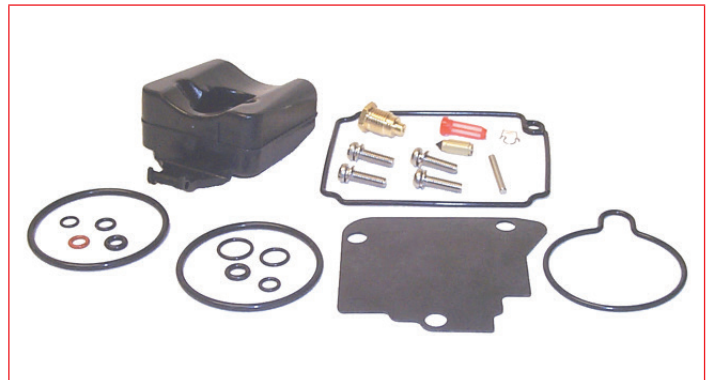

Artikel	Motor	Bouwjaar	Origineel onderdeel nummer
100534	F75, F90, F100 PK	v.a.'00	804346T02

Carburateurrevisiesets voor Tohatsu

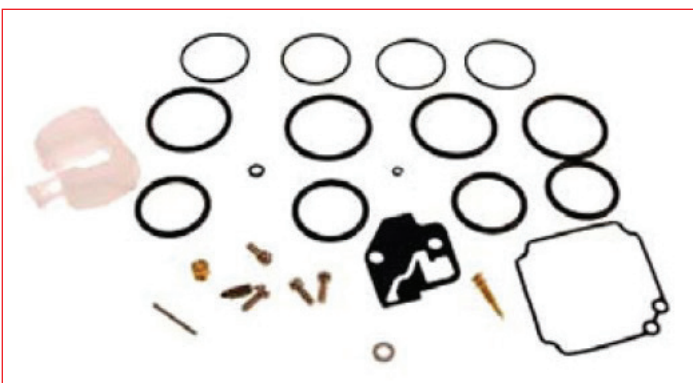

Artikel	Motor	Bouwjaar	Origineel onderdeel nummer
100538	F40 & F50 PK	97-'01	809594A1



Artikel	Motor	Bouwjaar	Origineel onderdeel nummer
100501	M2.5, M3.5	v.a.'84	3F0-87122-0

■ 2 Takt
 ■ 4 Takt
 ■ Inboard

-Vervolg- Carburateurrevisiesets Suzuki



Artikel	Motor	Bouwjaar	Origineel onderdeel nummer
100533	F4, F6	05	OEM nummer onbekend

Carburateur revisiesets Yamaha



Artikel	Motor	Bouwjaar	Origineel onderdeel nummer
100501	2 PK	84-'88	6A1-W0093-01



Artikel	Motor	Bouwjaar	Origineel onderdeel nummer
100502	3, 6, 8 PK	84-'96	6G1-W0093-00 , 369-871221-0



Artikel	Motor	Bouwjaar	Origineel onderdeel nummer
100503	4, 5 PK	84-'02	6E3-W0093-00, 6E0-W0093-00



Artikel	Motor	Bouwjaar	Origineel onderdeel nummer
100504	9.9, 15 PK	85-'95	6E7-W0093-04



Artikel	Motor	Bouwjaar	Origineel onderdeel nummer
100505	9.9, 15 PK	96-'06	63V-W0093-00

■ 2 Takt
 ■ 4 Takt
 ■ Inboard

- Vervolg - Carburateur revisiesets Yamaha



Artikel	Motor	Bouwjaar	Origineel onderdeel nummer
100506	40 PK	Model G + J	6F6-W0093-00



Artikel	Motor	Bouwjaar	Origineel onderdeel nummer
100507	40 PK	Model X	66T-W0093-00



Artikel	Motor	Bouwjaar	Origineel onderdeel nummer
100509	F2,5 PK	v.a. '03	69M-W0093-00



Artikel	Motor	Bouwjaar	Origineel onderdeel nummer
100510	F4 PK	99-'02	67D-W0093-01



Artikel	Motor	Bouwjaar	Origineel onderdeel nummer
100511	F15 PK	98-'04	66M-W0093-01

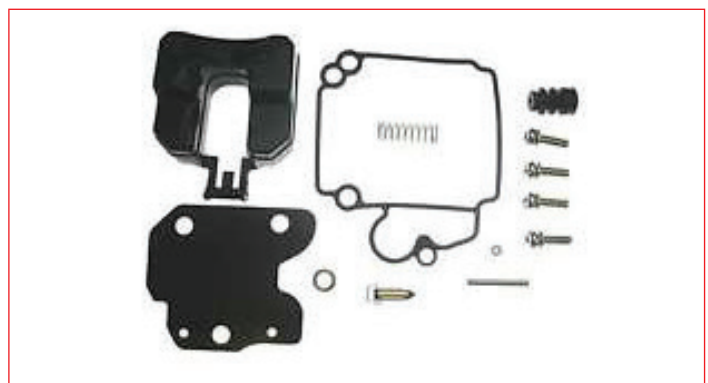

Artikel	Motor	Bouwjaar	Origineel onderdeel nummer
100512	F30, F40 PK	01-'05	67C-W0093-00

■ 2 Takt
 ■ 4 Takt
 ■ Inboard

- Vervolg - Carburateur revisiesets Yamaha

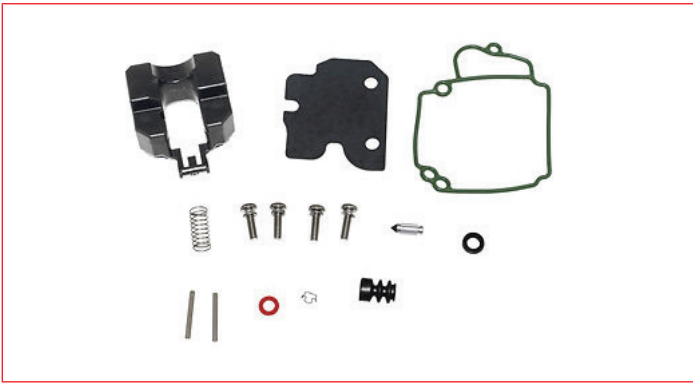

Artikel	Motor	Bouwjaar	Origineel onderdeel nummer
100513	F25 PK	v.a.'06	6BL-W0093-00



Artikel	Motor	Bouwjaar	Origineel onderdeel nummer
100514	25, 30 PK	94-'97	61N-W0093-00



Artikel	Motor	Bouwjaar	Origineel onderdeel nummer
100515	F50 PK	01-'04	62Y-W0093-11

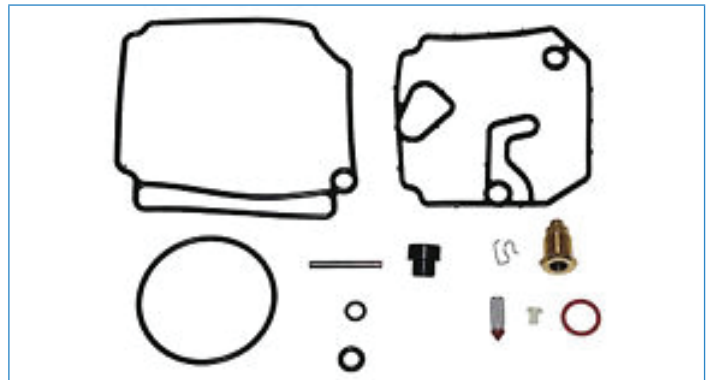

Artikel	Motor	Bouwjaar	Origineel onderdeel nummer
100516	75, 85, 90	92-'07	6H1-W0093-10



Artikel	Motor	Bouwjaar	Origineel onderdeel nummer
100521	9.9, 15 PK	94-'95	6E8-14301-00



Artikel	Motor	Bouwjaar	Origineel onderdeel nummer
100522	9.9, 15 PK	96-'03	63V-14301-00

■ 2 Takt
 ■ 4 Takt
 ■ Inboard

- Vervolg - Carburateurrevisiesets Yamaha



Artikel	Motor	Bouwjaar	Origineel onderdeel nummer
100523	40, 50 PK	84-'88	6H4-W0093-01

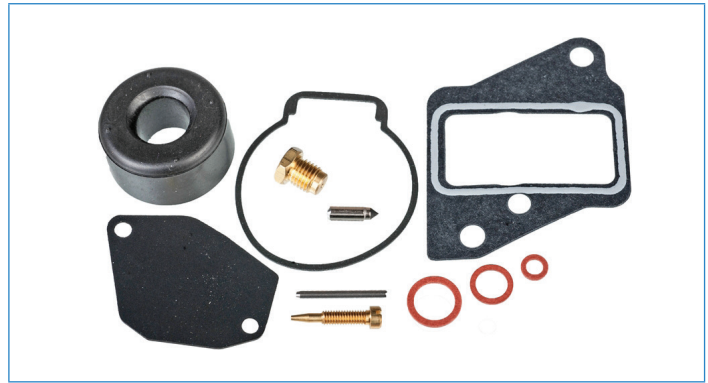

Artikel	Motor	Bouwjaar	Origineel onderdeel nummer
100524	9.9, 15 PK	84-'85	677-W0093-00



Artikel	Motor	Bouwjaar	Origineel onderdeel nummer
100525	25, 30 PK	84-'97	6G0-W0093-00, 689-W0093-0



Artikel	Motor	Bouwjaar	Origineel onderdeel nummer
100527	150 PK, XR, V	02-'12	64D-W0093-00



Artikel	Motor	Bouwjaar	Origineel onderdeel nummer
100528	60, 70 PK	99-'07	6H2-W0093-10



Artikel	Motor	Bouwjaar	Origineel onderdeel nummer
100532	75, 85 PK	84-'00	6H1-W0093-00

■ 2 Takt
 ■ 4 Takt
 ■ Inboard

- Vervolg - Carburateurrevisiesets Yamaha

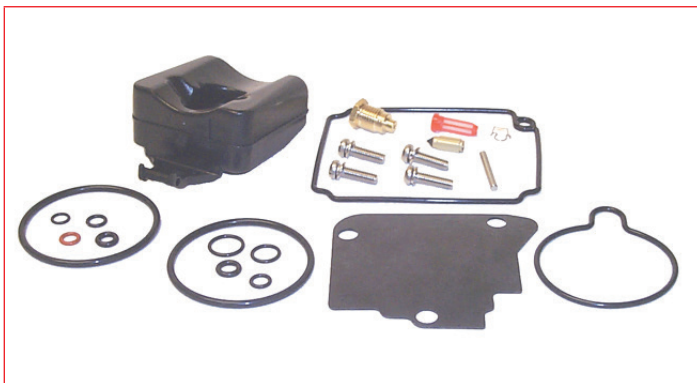

Artikel	Motor	Bouwjaar	Origineel onderdeel nummer
100534	F75,F90, F100 PK	v.a.'00	67F-W0093-00

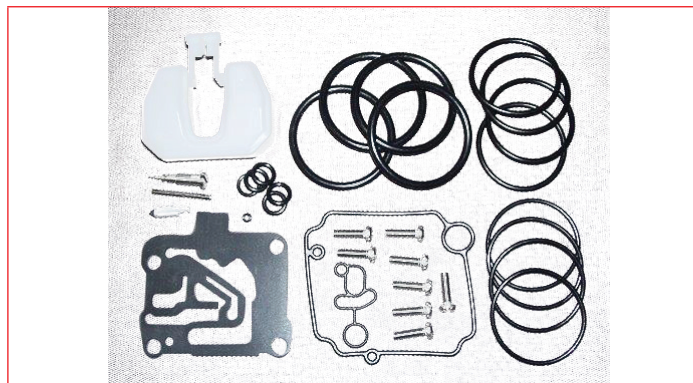

Artikel	Motor	Bouwjaar	Origineel onderdeel nummer
100535	F60 PK	02-'04	69W-W0093-10

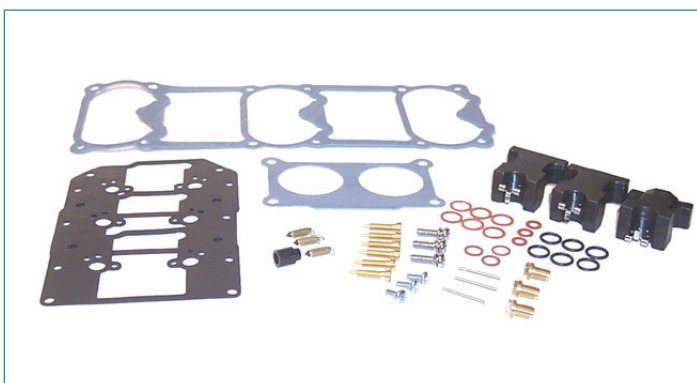

Artikel	Motor	Bouwjaar	Origineel onderdeel nummer
100536	150-175-200 PK	84-'86	6G5-W0093-07



Artikel	Motor	Bouwjaar	Origineel onderdeel nummer
100538	F40, F50 PK	95-'00	62Y-W0093-00



Artikel	Motor	Bouwjaar	Origineel onderdeel nummer
100545	60, 70 PK	91-'01	6H3-W0093-02, 6H2-W0093-01



Artikel	Motor	Bouwjaar	Origineel onderdeel nummer
100546	F8, F9,9 PK	96-'06	6G8-W0093-03

■ 2 Takt
 ■ 4 Takt
 ■ Inboard

- Vervolg - Carburateurrevisiesets Yamaha

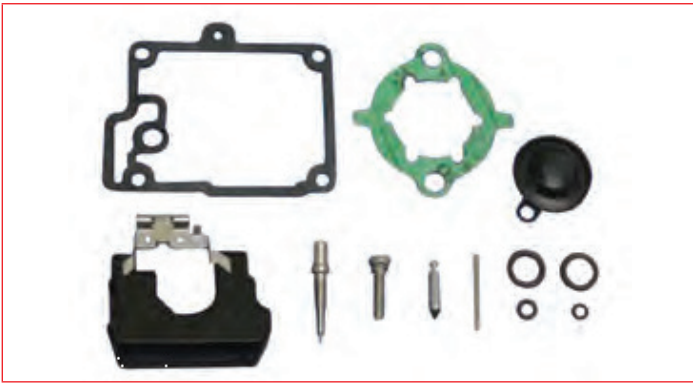

Artikel	Motor	Bouwjaar	Origineel onderdeel nummer
100547	F8, F9, 9 PK	85-'91	6G8-W0093-02



Artikel	Motor	Bouwjaar	Origineel onderdeel nummer
100548	20 PK	96-'97	6L2-W0093-00

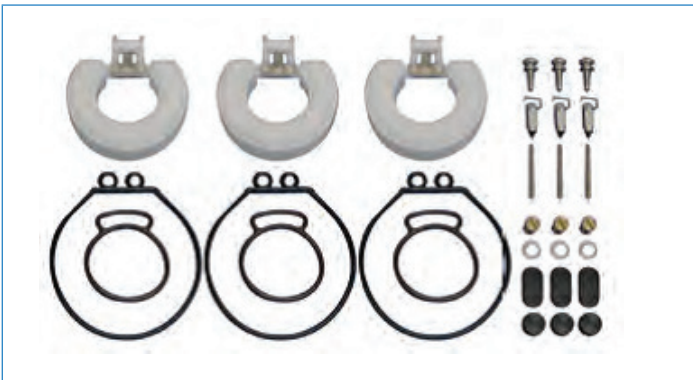

Artikel	Motor	Bouwjaar	Origineel onderdeel nummer
100549	25, 30 PK 3 Cil	87-'02	6J8-W0093-00



Artikel	Motor	Bouwjaar	Origineel onderdeel nummer
100550	40 PK	90-'93	6E9-W0093-02



Artikel	Motor	Bouwjaar	Origineel onderdeel nummer
100551	40 PK	94-'97	6E9-W0093-03

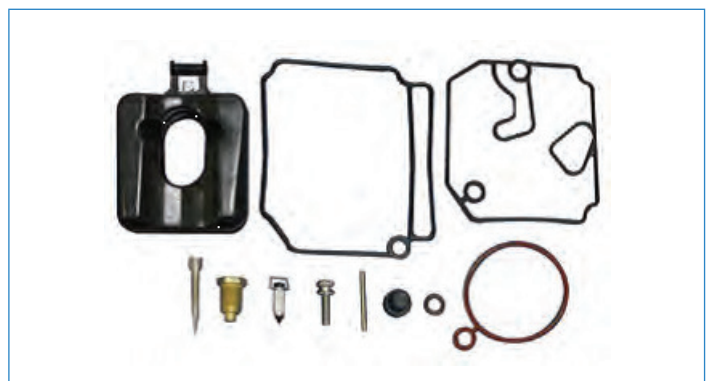

Artikel	Motor	Bouwjaar	Origineel onderdeel nummer
100552	40, 50 PK	98-'03	6H4-W0093-03

■ 2 Takt
 ■ 4 Takt
 ■ Inboard

Carburateurrevisiesets voor binnenboordmotoren



Artikel	Motor	Bouwjaar	Origineel onderdeel nummer
100701	Mercruiser	Rochester 4 Barrel	823426A1
100701	OMC		983564
100701	Volvo Penta		834985

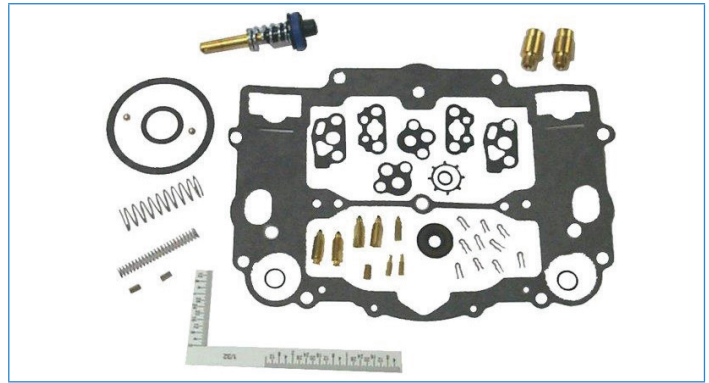

Artikel	Motor	Bouwjaar	Origineel onderdeel nummer
100702	Mercruiser 7.4, 8.1	Weber 4 Barrel	809064

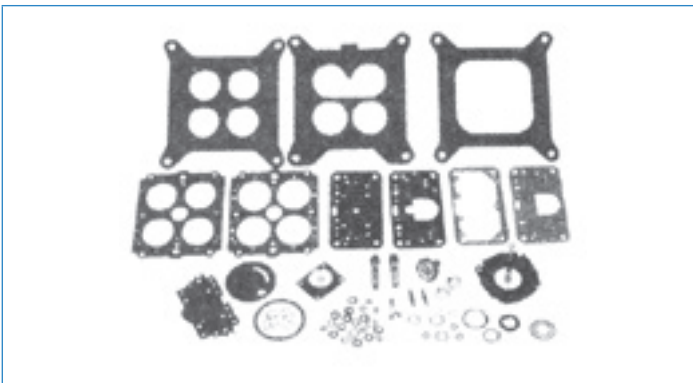

Artikel	Motor	Bouwjaar	Origineel onderdeel nummer
100703	Mercruiser-Ford 351 '70-'74	Holley 4 Barrel	1396-5238
100703	OMC		982539



Artikel	Motor	Bouwjaar	Origineel onderdeel nummer
100704	Mercruiser "HP" V8	Holley 4 Barrel	13220

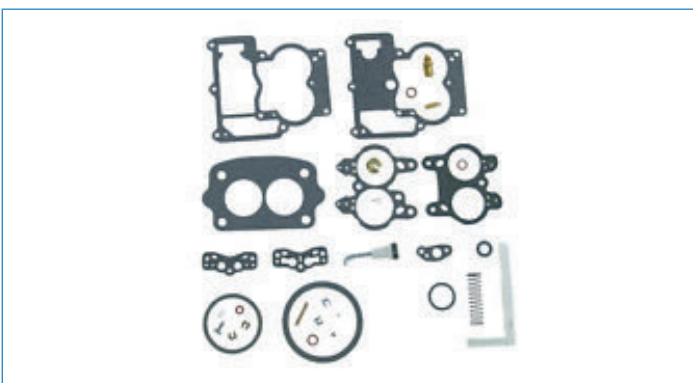

Artikel	Motor	Bouwjaar	Origineel onderdeel nummer
100705	GM 2.5, 3.0 4 cil , 6 cil	Rochester 2 Barrel	Mercruiser 823427A1, OMC 982384



Artikel	Motor	Bouwjaar	Origineel onderdeel nummer
100706	Mercruiser GM 3.7 4 cil	Rochester 2 Barrel	1397-6367A1

■ 2 Takt
 ■ 4 Takt
 ■ Inboard

- Vervolg - Carburateurrevisiesets voor binnenboordmotoren

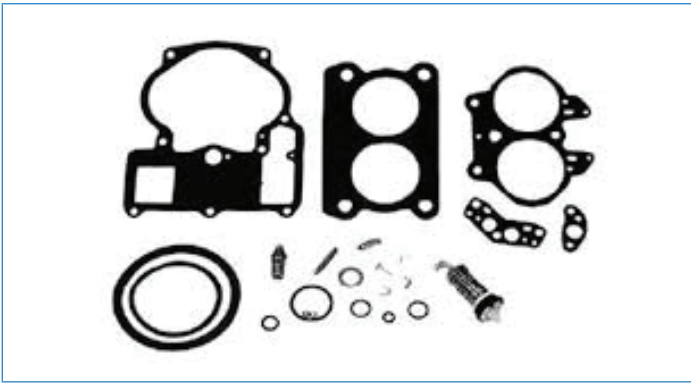

Artikel	Motor	Bouwjaar	Origineel onderdeel nummer
100707	Mercruiser Ford 302 V8	Rochester 2 Barrel	1397-8760



Artikel	Motor	Bouwjaar	Origineel onderdeel nummer
100708	Mercruiser GM 305 V8	Rochester 2 Barrel	1397-5831



Artikel	Motor	Bouwjaar	Origineel onderdeel nummer
100709	Mercruiser Ford 302 V8	Holley 2 Barrel	1396-4656
100709	OMC Ford 302 V8	Holley 2 Barrel	982538, 385052



Artikel	Motor	Bouwjaar	Origineel onderdeel nummer
100710	Mercruiser	Mercab 2 barrel '83-'86	3302-804845

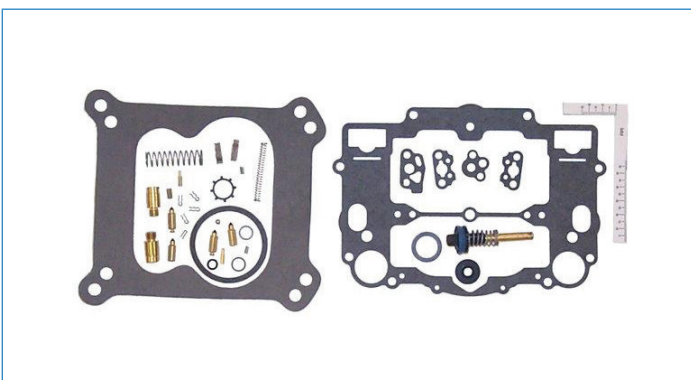

Artikel	Motor	Bouwjaar	Origineel onderdeel nummer
100720	Mercruiser GM 7.4, 8.2	Weber 4 Barrel '92-'95	809065

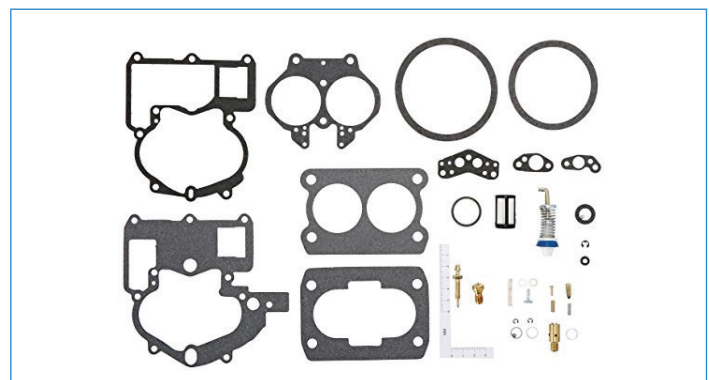

Artikel	Motor	Bouwjaar	Origineel onderdeel nummer
100711	Mercruiser	Mercab 2 Barrel v.a. '85	3320-804844

■ 2 Takt
 ■ 4 Takt
 ■ Inboard

- Vervolg - Carburateurrevisiesets voor binnenboordmotoren



Artikel	Motor	Bouwjaar	Origineel onderdeel nummer
100712	Mercr. Renault 80 HP	Carter 1 barrel '66-'69	1398-3089



Artikel	Motor	Bouwjaar	Origineel onderdeel nummer
100713	Mercuiser. OMC 110, 150 HP	Rochester 1 Barrel '64-'69	Merc 1397-3458 OMC 380186

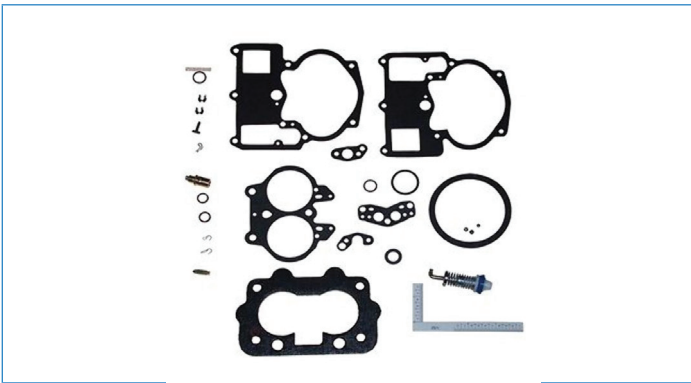

Artikel	Motor	Bouwjaar	Origineel onderdeel nummer
100714	OMC, Volvo GM 5.0, 5.7	Rochester 2 Barrel '86-'89	OMC 984487, Volvo 841994



Artikel	Motor	Bouwjaar	Origineel onderdeel nummer
100715	Volvo Penta 740A 55A	Holley 4 Barrel	Geen OEM Nummer



Artikel	Motor	Bouwjaar	Origineel onderdeel nummer
100716	Volvo Penta AQ 115 AB	Solex Carburateur	841836, 841292
100716	AQ 125 AB, AQ130CD		
100716	AQ 131 ABCD, 145 AB. BB		
100716	AQ 151 ABCD, 171 AC, 145A		



Artikel	Motor	Bouwjaar	Origineel onderdeel nummer
100717	Volvo Penta AQ 80	1 Barrel Carburateur	Geen OEM Nummer

■ 2 Takt
 ■ 4 Takt
 ■ Inboard

- Vervolg - Carburateurrevisiesets voor binnenboordmotoren

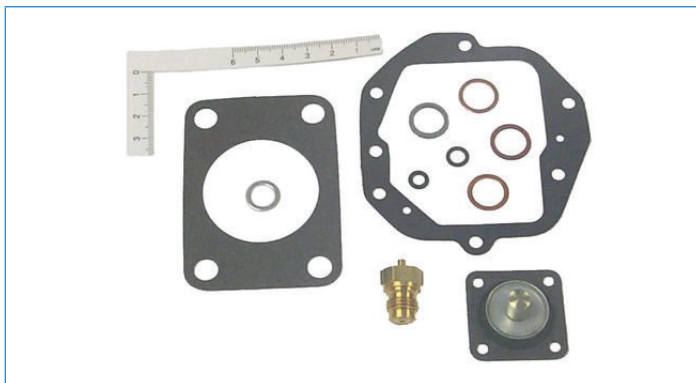

Artikel	Motor	Bouwjaar	Origineel onderdeel nummer
100718	Volvo Penta AQ 120B	1 Barrel Carburateur	841293
100718	AQ 140 A, BB 140 A		



Artikel	Motor	Bouwjaar	Origineel onderdeel nummer
100719	Volvo Penta AQ 120		
100719	AQ 130 A,B BB 115 A	Zenith / Stromberg	875407

■ 2 Takt
 ■ 4 Takt
 ■ Inboard

Benzine pompen voor 2-takt buitenboordmotoren



Artikel	Motor	Bouwjaar	Origineel onderdeel nummer
100301	Johnson / Evinrude 20 - 30 PK	'90-'00	438555 / 18-7353



Artikel	Motor	Bouwjaar	Origineel onderdeel nummer
100302	Johnson / Evinrude 25 - 140 PK	Alle typen met 3 aansluitingen	438559, 0385784, 0394716, 0398385



Artikel	Motor	Bouwjaar	Origineel onderdeel nummer
100303	Johnson / Evinrude 20 - 140 PK	Alle typen met 2 aansluitingen	438556, 388268, 432451, 433387

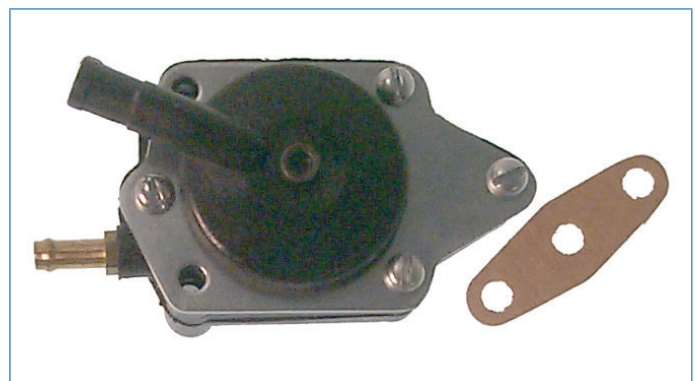

Artikel	Motor	Bouwjaar	Origineel onderdeel nummer
100304	Johnson / Evinrude 6 - 15 PK	1993 - 2001	438562



Artikel	Motor	Bouwjaar	Origineel onderdeel nummer
100305	Mercury 30 - 250 PK	1988 - 1993	8M0036779 14360A78



Artikel	Motor	Bouwjaar	Origineel onderdeel nummer
100306	Johnson / Evinrude 6 - 15 PK	tot 1993	397839

■ 2 Takt
 ■ 4 Takt
 ■ Inboard

- Vervolg -Benzine pompen voor 2-takt buitenboordmotoren



Artikel	Motor	Bouwjaar	Origineel onderdeel nummer
100307	Yamaha 30 - 85 PK	vanaf '94	692-24410-00 , 6A0-24410-00
	Mercury 30 - 90 PK		43113M
	Tohatsu 30 - 90 PK		356-04000-1
	Suzuki		15100-94300



Artikel	Motor	Bouwjaar	Origineel onderdeel nummer
100308	Yamaha 115 - 300 PK V4 & V6	vanaf '84	6E5-24410-00

Benzine pompen voor 4 -takt buitenboordmotoren



Artikel	Motor	Bouwjaar	Origineel onderdeel nummer
100351	Tohatsu 4 - 9,8 PK	vanaf '98	3H6-04000-7
	Mercury 4 - 9,9 PK	vanaf '98 (8 & 9,9 vanaf '06)	803529T06
	Evinrude	vanaf '12	5040977



Artikel	Motor	Bouwjaar	Origineel onderdeel nummer
100352	Yamaha 4 - 6 PK	vanaf '00	67D-24410-02
100352	Suzuki		15100-91J00
100352	Johnson		5033371

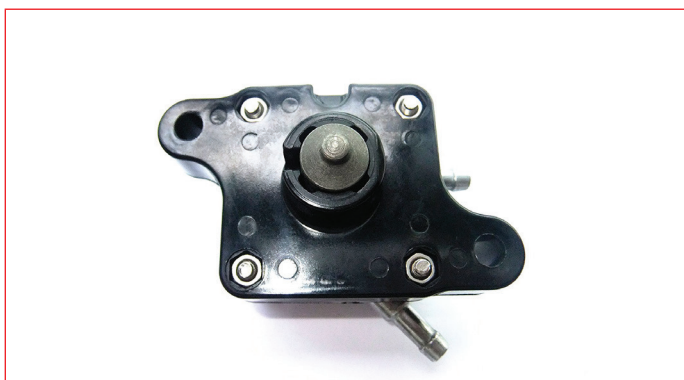

Artikel	Motor	Bouwjaar	Origineel onderdeel nummer
100353	Yamaha 6, 8, 9,9 PK	vanaf '06	68T-24410-00



Artikel	Motor	Bouwjaar	Origineel onderdeel nummer
100354	Yamaha 9,9 - 15 PK	vanaf '05	66M-24410-10
100354	Mercury 9.9 - 15 PK	vanaf '05	825470

■ 2 Takt
 ■ 4 Takt
 ■ Inboard

Benzine pompen voor 4 -takt buitenboordmotoren



Artikel	Motor	Bouwjaar	Origineel onderdeel nummer
100355	Yamaha 15 PK	vanaf '12	6AH-24410-00
	Yamaha 20 PK	vanaf '06	

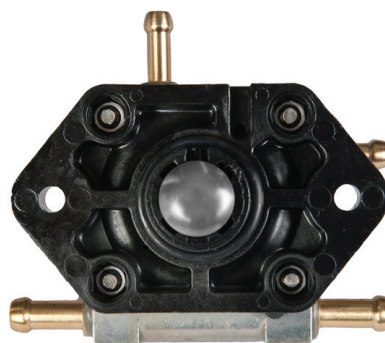

Artikel	Motor	Bouwjaar	Origineel onderdeel nummer
100356	Mercury 40 - 60 PK	vanaf '06	899106T01



Artikel	Motor	Bouwjaar	Origineel onderdeel nummer
100357	Yamaha 40 - 60 PK	'05 - '12	6C5-24410-00



Artikel	Motor	Bouwjaar	Origineel onderdeel nummer
100358	Yamaha 25 - 60 PK	'95-'04	62Y-24410-04
	Mercury 25 - 60 PK	4 cilinder modellen	826398T3 , 826398A3



Artikel	Motor	Bouwjaar	Origineel onderdeel nummer
100359	Yamaha 80-115 PK	Vanaf '00	68V-24410-00

■ 2 Takt
 ■ 4 Takt
 ■ Inboard

Revisiesets voor 2-takt brandstofpompen



Artikel	Motor	Bouwjaar	Origineel onderdeel nummer
100375	Joh / Ev. 2.5-15 PK	77-'93	393088



Artikel	Motor	Bouwjaar	Origineel onderdeel nummer
100376	Joh / Ev 9.9-60 PK	76-'84	393103

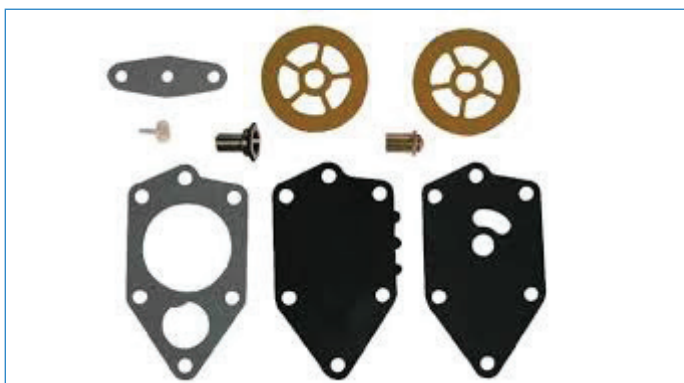

Artikel	Motor	Bouwjaar	Origineel onderdeel nummer
100377	Joh / Ev 9.9-60 PK	85-'90	398514



Artikel	Motor	Bouwjaar	Origineel onderdeel nummer
100378	Joh / Ev 20-50 PK	88-'90	432962



Artikel	Motor	Bouwjaar	Origineel onderdeel nummer
100379	Joh / Ev 40-50 PK	v.a. '90	438616

■ 2 Takt
 ■ 4 Takt
 ■ Inboard

Revisiesets voor 2-takt brandstofpompen



Artikel	Motor	Bouwjaar	Origineel onderdeel nummer
100380	Yam 40-90 PK	alle 2-takt	Geen OEM nummer



Artikel	Motor	Bouwjaar	Origineel onderdeel nummer
100381	Yam 115-200 PK V4 & V6	alle 2-takt	Geen OEM nummer

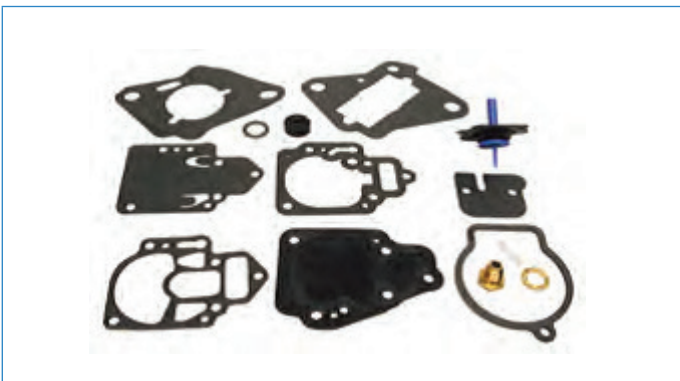

Artikel	Motor	Bouwjaar	Origineel onderdeel nummer
100385	Yam 6-20 PK	84-'90	1395-9761-1



Artikel	Motor	Bouwjaar	Origineel onderdeel nummer
100386	Yam 35 PK	66-'69	23014A1
100386	Yam 50 PK 4 Cil	67-'75	23014A1



Artikel	Motor	Bouwjaar	Origineel onderdeel nummer
100387	Yam 40 PK 2 Cil	70-'79	55278A1
100387	Yam 60 PK 3 Cil	84-'87	55278A1
100387	Yam 100, 150 PK	73-'77	55278A1



Artikel	Motor	Bouwjaar	Origineel onderdeel nummer
100388	Yam 75, 80 PK	84-'88	55278A5
100388	Yam 85 PK	73-'77	55278A5

■ 2 Takt
 ■ 4 Takt
 ■ Inboard

- Vervolg - Revisiesets voor 2-takt brandstofpompen



Artikel	Motor	Bouwjaar	Origineel onderdeel nummer
100389	Mercury 70 PK 3 Cil	77-'83	55278A4



Artikel	Motor	Bouwjaar	Origineel onderdeel nummer
100390	Mercury 90, 115, 140, 150 6 Cil	78-'79	89031A1

Revisiesets 4-takt brandstofpompen



Artikel	Motor	Bouwjaar	Origineel onderdeel nummer
100391	Merc 90 PK 6 Cil	79-'86	89031A3
100391	Merc 115 PK 6 Cil	79-'88	89031A3
100391	Merc 140 PK 6 Cil	80-'81	89031A3



Artikel	Motor	Bouwjaar	Origineel onderdeel nummer
100392	Johnson 10-15 PK 4-Takt	05-'07	5036216
100392	Suzuki 9.9 -15 PK 4-Takt	vanaf '05	15170-94J00



Artikel	Motor	Bouwjaar	Origineel onderdeel nummer
100393	Johnson 9.9-15 PK	02-'04	5030699
100393	Johnson 25, 30, 40, 70 PK	04-'06	5030699
100393	Suzuki 9.9,15 PK	97-'04	15170-99E00
100393	Suzuki 40-70 PK	99-'06	15170-99E00



Artikel	Motor	Bouwjaar	Origineel onderdeel nummer
100394	Johnson 4-5 PK	03-'06	5033372
100394	Johnson 6 PK	05-'06	5033372
100394	Suzuki 4, 5, 6 PK	03-'06	15170-91J00

■ 2 Takt
 ■ 4 Takt
 ■ Inboard

Elektrische benzinepompen Yamaha



Artikel	Motor	Bouwjaar	Origineel onderdeel nummer
100401	225-250-300 PK Z. LZ, VZ	03-'09	60V-13907-00-00



Artikel	Motor	Bouwjaar	Origineel onderdeel nummer
100402	150-250 PK, DX, LX, VX, SX, V	99-'01	66K-13907-00-00



Artikel	Motor	Bouwjaar	Origineel onderdeel nummer
100403	150-200 PK LZ,VZ,Z	00-'12	68F-13907-01-00

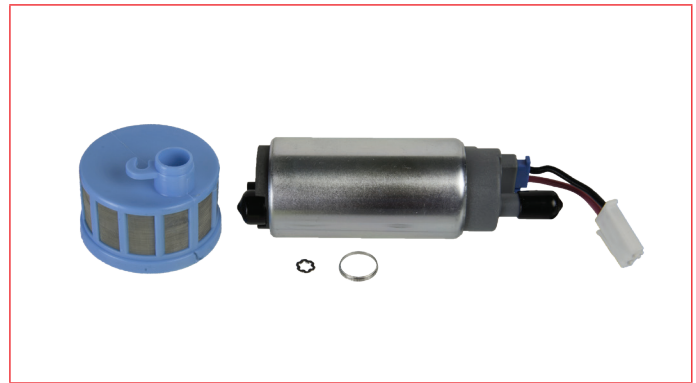

Artikel	Motor	Bouwjaar	Origineel onderdeel nummer
100404	F115	00-'11	68V-13907-00-00



Artikel	Motor	Bouwjaar	Origineel onderdeel nummer
100405	F150	03-'16	63P-13907-00-00



Artikel	Motor	Bouwjaar	Origineel onderdeel nummer
100406	F200-F225-F250	05-'12	6P2-13907-00-00, 6AW-13907-00-00

■ 2 Takt
 ■ 4 Takt
 ■ Inboard

- Vervolg - Elektrische benzinepompen Yamaha



Artikel	Motor	Bouwjaar	Origineel onderdeel nummer
100407	F200-F225	02-'03	69J-13907-00-00



Artikel	Motor	Bouwjaar	Origineel onderdeel nummer
100408	F50-F60-F70-F90	v.a.2005	6C5-13907-00-00



Artikel	Motor	Bouwjaar	Origineel onderdeel nummer
100418	F200-F225-F250	02-'15	69J-24410-00-00

Elektrische benzinepompen Mercury, Mariner



Artikel	Motor	Bouwjaar	Origineel onderdeel nummer
100405	F115	02-'06	880889T, T01, 8M0123823



Artikel	Motor	Bouwjaar	Origineel onderdeel nummer
100407	F225	02-'06	888246T / T01

■ 2 Takt
 ■ 4 Takt
 ■ Inboard

- Vervolg - Elektrische benzinepompen Mercury, Mariner

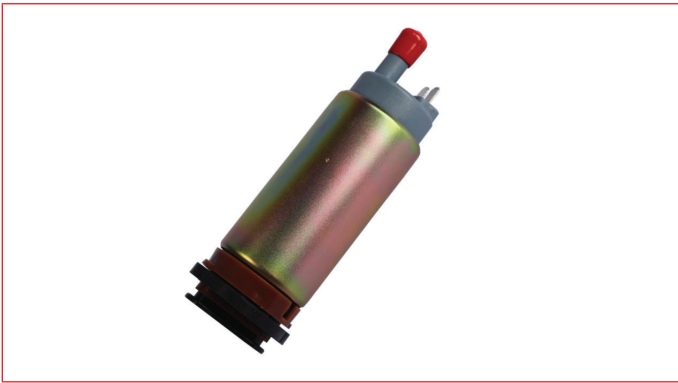

Artikel	Motor	Bouwjaar	Origineel onderdeel nummer
100409	F30-F60	02-'10	892267A51



Artikel	Motor	Bouwjaar	Origineel onderdeel nummer
100412	F30-F40-F50-F60	02-'06	883202T02



Artikel	Motor	Bouwjaar	Origineel onderdeel nummer
100411	F75-F115 EFI 135-350 VERADO	05-'11	880596T58



Artikel	Motor	Bouwjaar	Origineel onderdeel nummer
100414	F25-F30	v.a.'06	898101T67



Artikel	Motor	Bouwjaar	Origineel onderdeel nummer
100413	Optimax	'03	888733T02

■ 2 Takt
 ■ 4 Takt
 ■ Inboard

- Vervolg - Elektrische benzinepompen Mercury, Mariner



Artikel	Motor	Bouwjaar	Origineel onderdeel nummer
100415	Optimax 75-300	v.a. '03	888725T02

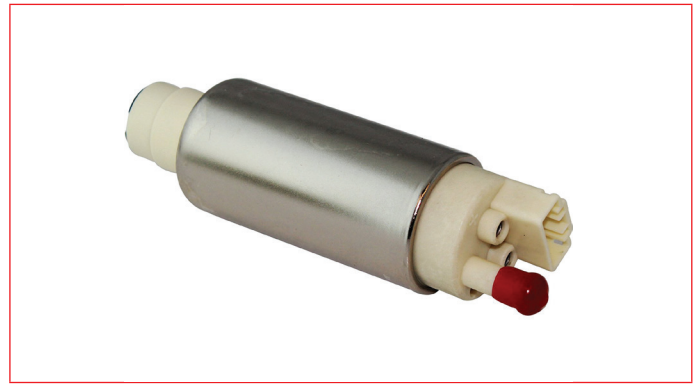

Artikel	Motor	Bouwjaar	Origineel onderdeel nummer
100416	F135-F300 Verado	v.a. '07	886596T55, 881705T1



Artikel	Motor	Bouwjaar	Origineel onderdeel nummer
100417	150 PK - 250 PK	v.a. '98	808505T, 824682T, 809088T-1



Artikel	Motor	Bouwjaar	Origineel onderdeel nummer
100418	F225	03-'06	888251T02, 888251T



Artikel	Motor	Bouwjaar	Origineel onderdeel nummer
100419	150-175-225	92-'97	14307A1



Artikel	Motor	Bouwjaar	Origineel onderdeel nummer
100420	110-225	98-'10	8M0047624

■ 2 Takt
 ■ 4 Takt
 ■ Inboard

Elektrische benzinepompen Johnson / Evinrude



Artikel	Motor	Bouwjaar	Origineel onderdeel nummer
100429	E-Tec 3.3 & 3.4 L	v.a. '04	5006063, 5009118



Artikel	Motor	Bouwjaar	Origineel onderdeel nummer
100434	Ficht modellen	02-'05	5004429

Elektrische benzinepompen Suzuki



Artikel	Motor	Bouwjaar	Origineel onderdeel nummer
100407	115 - 140 PK	03-'06	5032617, 5033702



Artikel	Motor	Bouwjaar	Origineel onderdeel nummer
100404	F90-F175	06-'14	15200-96J00



Artikel	Motor	Bouwjaar	Origineel onderdeel nummer
100435	DF40-DF300	v.a.01	15200-90J00



Artikel	Motor	Bouwjaar	Origineel onderdeel nummer
100407	115 - 140 PK	01-'07	15200-87J10

■ 2 Takt
 ■ 4 Takt
 ■ Inboard

Elektrische benzinepompen Tohatsu



Artikel	Motor	Bouwjaar	Origineel onderdeel nummer
100414	F25-F30	v.a. '05	3AC-04302-0



Artikel	Motor	Bouwjaar	Origineel onderdeel nummer
100415	TLDi	v.a. '00	3T5-04302-0

■ 2 Takt
 ■ 4 Takt
 ■ Inboard

- Vervolg - Elektrische benzinepompen Mercruiser



Artikel	Motor	Bouwjaar	Origineel onderdeel nummer
100410	Mercruiser 305,350,377,496	Uitvoering met Gen III Cool Fuel Module	866170A01

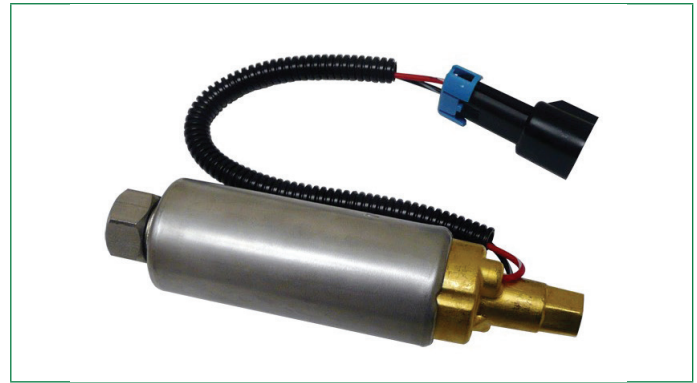

Artikel	Motor	Bouwjaar	Origineel onderdeel nummer
100423	Mercruiser V6	MCM262, 4,3L/LX/LH/LXH	861155A6



Artikel	Motor	Bouwjaar	Origineel onderdeel nummer
100424	Mercruiser V6-V8	Model O10.... t/m OM29999	861156A02

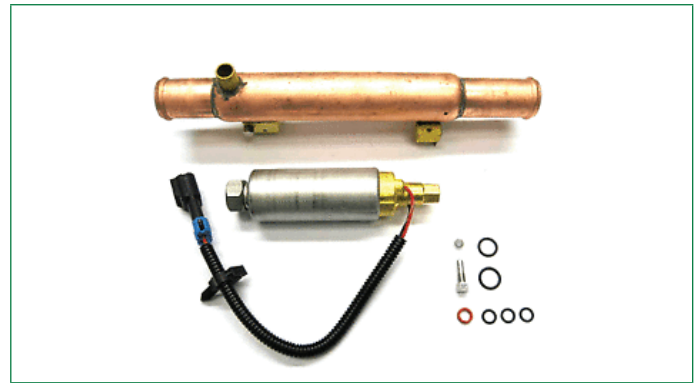

Artikel	Motor	Bouwjaar	Origineel onderdeel nummer
100425	Mercruiser V6-V8	vanaf model OM3.....	861156A03

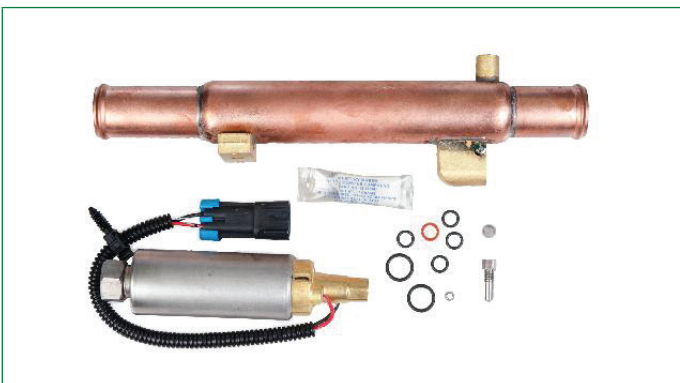

Artikel	Motor	Bouwjaar	Origineel onderdeel nummer
100426	Mercruiser GM V6-V8	tot en met model OK 999999	861156A04



Artikel	Motor	Bouwjaar	Origineel onderdeel nummer
100431	Mercruiser V6-V8 , 4.3 / 5.8	v.a. '93	805656A5

■ 2 Takt
 ■ 4 Takt
 ■ Inboard

Elektrische benzinepompen Mercruiser



Artikel	Motor	Bouwjaar	Origineel onderdeel nummer
100421	Mercruiser 305,350,454,502	98-'00	861155A3



Artikel	Motor	Bouwjaar	Origineel onderdeel nummer
100422	Mercruiser 305,350,454,502	98-'00	861156A1

- Vervolg - Elektrische benzinepompen Volvo Penta / OMC



Artikel	Motor	Bouwjaar	Origineel onderdeel nummer
100427	4.3 / 5.0 / 5.7 , 7.4 / 8.1	Model Gxi, Gi, GiC	3588865, 3861355, 3860210



Artikel	Motor	Bouwjaar	Origineel onderdeel nummer
100428	V8 : 7.4 & 8.2 L	Carbureateur modellen	3858714, 3850810, 3858714



Artikel	Motor	Bouwjaar	Origineel onderdeel nummer
100430	V6 & V8	94-'96	3857650



Artikel	Motor	Bouwjaar	Origineel onderdeel nummer
100431	V6 & Small V8	Carbureateur modellen	385261, 3850809, 3854620, 3857986

■ 2 Takt
 ■ 4 Takt
 ■ Inboard

- Vervolg - Elektrische benzinepompen Volvo Penta / OMC



Artikel	Motor	Bouwjaar	Origineel onderdeel nummer
100433	V6 ; 4.3 V8: 5.0, 5.7	Osi, GXi Gi, SXi	21608511, 21545138, 359444, 3861355

Mercuriser Injectoren



Artikel	Motor	Bouwjaar	Origineel onderdeel nummer
100601	Mercuriser 350 MAG	02-'09	885176



Artikel	Motor	Bouwjaar	Origineel onderdeel nummer
100602	Mercuriser V6-V8	98-'02	861260T

■ 2 Takt
 ■ 4 Takt
 ■ Inboard



 2 Takt  4 Takt  Inboard

Brandstoffilters



Artikel	Omschrijving
107853	Filter Mercury Compleet
107847	Filterelement Mercury
107859	Filter Yamaha Compleet
107848	Filterelement Yamaha
107849	Aftapglas voor filterelement



Artikel	Omschrijving
107851	Benzinefilter (10 micron)
107844	Papieren filter element voor filterset
107850	Benzinefilterelement met waterafscheider



Artikel	Omschrijving
107852	Waterafscheider compleet
107845	Filterelement voor 107852 o.a. voor Mercruiser
107846	Filterelement voor OMC no. 502905 o.a. voor Cobra sterndive



Artikel	Omschrijving
108950	Klein model transparant voor BBM voor 1/4 " brandstofleiding



Artikel	Omschrijving
108951	Groot model wit voor BBM voor 5/16 " brandstofleiding



Artikel	Omschrijving
109050	Groot model wit filter voor 1/4 " brandstofleiding



Artikel	Omschrijving
109051	Groot model wit filter voor 3/8 " brandstofleiding

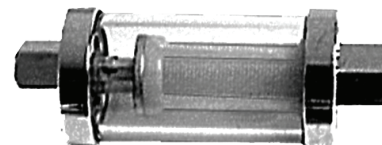

Artikel	Omschrijving
108960	Model chrom / glas met verwisselbaar filterelement
108961	3 x filterelement voor 108960

- Vervolg - Brandstoffilters



Artikel	Motor	Bouwjaar	Origineel onderdeel nummer
107840	Yamaha, Suzuki	n.v.t.	907-94469-07



Artikel	Motor	Bouwjaar	Origineel onderdeel nummer
107841	Yamaha, Suzuki, Tohatsu	n.v.t.	61N-24560-00



Artikel	Motor	Bouwjaar	Origineel onderdeel nummer
100801	Yamaha	9.9-50 PK	61N-24563-00



Artikel	Motor	Bouwjaar	Origineel onderdeel nummer
100802	Yamaha	9.9-300 PK	646-24251-02
100802	Mercury	9.9-200 PK	35-80365M



Artikel	Motor	Bouwjaar	Origineel onderdeel nummer
100803	Yamaha	225-250 PK	65L-13915-00
100803	Mercury	225-250 PK	35-888289T02



Artikel	Motor	Bouwjaar	Origineel onderdeel nummer
100804	Yamaha	225-250 PK	65L-24563-00
100804	Suzuki	225-250 PK	15412-93J00
100804	Mercury	225-250 PK	35-888-289T2



Artikel	Motor	Bouwjaar	Origineel onderdeel nummer
100805	Yamaha	150-250 PK	66K-13915-00



Artikel	Motor	Bouwjaar	Origineel onderdeel nummer
100806	Yamaha	150-225 PK	68F-13915-00

- Vervolg - Brandstoffilters



Artikel	Motor	Bouwjaar	Origineel onderdeel nummer
100807	Yamaha	70-115 PK	68V-24563-00
100807	Mercury	70-115 PK	881940



Artikel	Motor	Bouwjaar	Origineel onderdeel nummer
100808	Yamaha	90-90 PK	6C5-24251-00



Artikel	Motor	Bouwjaar	Origineel onderdeel nummer
100809	Yamaha	40-115 PK	6D8-WS24A-00

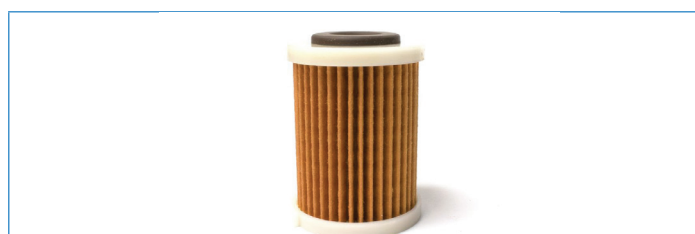

Artikel	Motor	Bouwjaar	Origineel onderdeel nummer
100810	Yamaha	150-300 PK	6P3-24563-00



Artikel	Motor	Bouwjaar	Origineel onderdeel nummer
100811	Yamaha	8-300 PK	90794-46868
100811	Suzuki	8-300 PK	65910-98J00



Artikel	Motor	Bouwjaar	Origineel onderdeel nummer
100820	Suzuki	40-50 PK	15410-87J00



Artikel	Motor	Bouwjaar	Origineel onderdeel nummer
100821	Suzuki	25-140 PK	15410-87J10



Artikel	Motor	Bouwjaar	Origineel onderdeel nummer
100822	Suzuki	25-140 PK	15410-87J30

- Vervolg - Brandstoffilters



Artikel	Motor	Bouwjaar	Origineel onderdeel nummer
100823	Suzuki	70-90 PK	15410-87L00



Artikel	Motor	Bouwjaar	Origineel onderdeel nummer
100824	Suzuki	150-175 PK	15410-96J00



Artikel	Motor	Bouwjaar	Origineel onderdeel nummer
100825	Suzuki	3,5-175 PK	15410-98500



Artikel	Motor	Bouwjaar	Origineel onderdeel nummer
100830	Mercury	4-20 PK	35-16248
100830	Tohatsu	4-18 PK	369-02230-0
100830	Honda	5-30 PK	16910-GB2-005



Artikel	Motor	Bouwjaar	Origineel onderdeel nummer
100835	Honda	90-250 PK	16911-ZY3-010



Artikel	Motor	Bouwjaar	Origineel onderdeel nummer
100836	Honda	115-200 PK	16901-ZY3-003



Artikel	Motor	Bouwjaar	Origineel onderdeel nummer
100850	Mercuriser		35-53336Q



Artikel	Motor	Bouwjaar	Origineel onderdeel nummer
100851	Mercuriser		35-93568

- Vervolg - Brandstoffilters



Artikel	Motor	Bouwjaar	Origineel onderdeel nummer
100852	Mercurius		1397-8767Q



Artikel	Motor	Bouwjaar	Origineel onderdeel nummer
100853	Mercurius		1397-2150



Artikel	Motor	Bouwjaar	Origineel onderdeel nummer
100854	Mercurius		35-803897Q
100854	Volvo Penta / OMC		509263



Artikel	Motor	Bouwjaar	Origineel onderdeel nummer
100855	Volvo Penta / OMC		982230

Benzine Connectoren motorzijde



Artikel	Omschrijving	Aansluitzijde
108944	Honda Voor slang Ø 8 mm	motor



Artikel	Omschrijving	Aansluitzijde
108945	HONDA, voor slang Ø 6 - 8 mm	motor

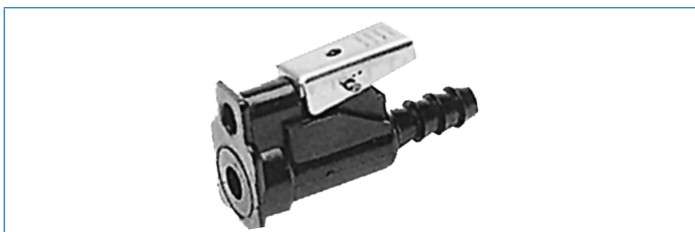

Artikel	Omschrijving	Aansluitzijde
108931	JOHNSON, EVINRUDE, SUZUKI 4-takt Voor slang Ø 8 - 10 mm	motor



Artikel	Omschrijving	Aansluitzijde
108949	Johnson, Evinrude Voor slang Ø 8 mm	motor

Benzine Connectoren motorzijde

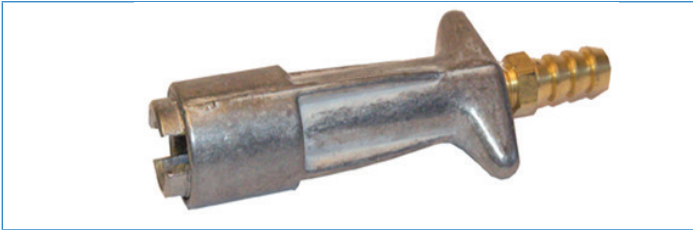

Artikel	Omschrijving	Aansluitzijde
108921	MERCURY, Metaal uitvoering Voor slang Ø 8 mm	motor



Artikel	Omschrijving	Aansluitzijde
108932	Suzuki, voor slang Ø 6 - 8 mm (Suzuki t/m 20 Pk.)	motor



Artikel	Omschrijving	Aansluitzijde
108933	Suzuki, voor slang Ø 8 - 10 mm (Suzuki DF25 - DF140)	motor



Artikel	Omschrijving	Aansluitzijde
108941	TOHATSU, YAMAHA, Voor slang Ø 8 -10 mm	motor

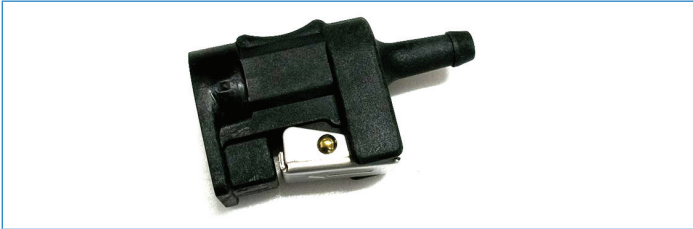

Artikel	Omschrijving	Aansluitzijde
108943	Yamaha, voor slang Ø 6 - 8 mm	motor



Artikel	Omschrijving	Aansluitzijde
108942	Yamaha, voor slang Ø 8 - 10 mm	motor

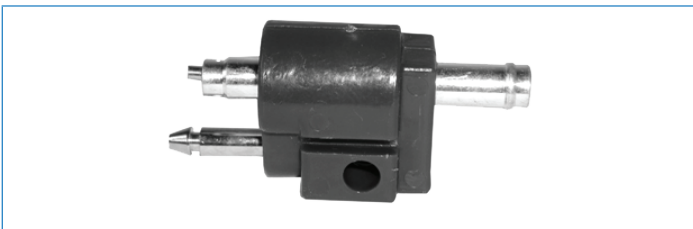

Artikel	Omschrijving	Aansluitzijde
108948	YAMAHA, MARINER, MERCURY (Op deze stekker past stekker 108941), slang Ø 8 m m	motor



Artikel	Omschrijving	Aansluitzijde
108939	Yamaha Voor slang Ø 5-6 mm	motor

- Vervolg - Benzine Connectoren motorzijde

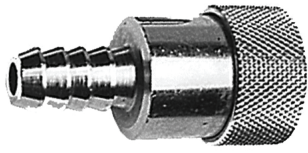

Artikel	Omschrijving	Aansluitzijde
108981	TOHATSU, NISSAN past op 108984 en 108982, voor slang Ø 10 mm	motor

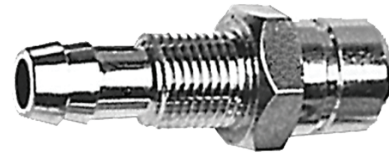

Artikel	Omschrijving	Aansluitzijde
108982	TOHATSU, NISSAN met slangpilaar, contra voor 108981, voor slang Ø 8 mm	motor



Artikel	Omschrijving	Aansluitzijde
108984	TOHATSU, NISSAN contra voor 108981	motor

Benzine Connectoren tankzijde



Artikel	Omschrijving	Aansluitzijde
108922	MERCURY, Metaal uitvoering Voor slang Ø 8 mm	tank



Artikel	Omschrijving	Aansluitzijde
108956	MERCURY, MARINER Voor slang Ø 8 mm	tank



Artikel	Omschrijving	Aansluitzijde
108946	SUZUKI, CHRYSLER, FORCE Voor slang Ø 10 mm	tank

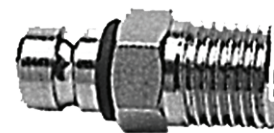

Artikel	Omschrijving	Aansluitzijde
108947	TOHATSU, YAMAHA, Voor slang Ø 8 -10 mm	tank

Benzine Connectoren tankzijde

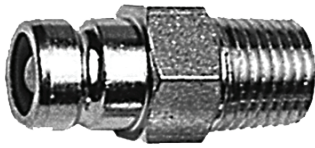

Artikel	Omschrijving	Aansluitzijde
108983	TOHATSU, HONDA, SUZUKI, NISSAN contra voor 108985	tank



Artikel	Omschrijving	Aansluitzijde
108985	TOHATSU, HONDA, SUZUKI, NISSAN contra voor 108983, voor slang Ø 10 mm	tank

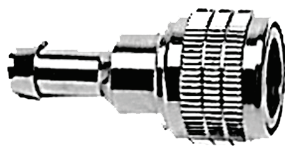

Artikel	Omschrijving	Aansluitzijde
108991	HONDA, voor slang Ø 10 mm v.a. 1991	tank



Artikel	Omschrijving	Aansluitzijde
108992	HONDA, contra voor 108991	tank

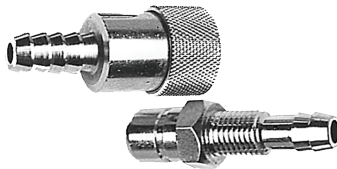

Artikel	Omschrijving	Aansluitzijde
108988	Male en Female met 2x slangpilaar en aan beide zijden een kogelafsluiter Aansluiting slang van de tank Ø 10 mm	in slang
108989	Losse moer voor 'male' aansluiting slang van de tank Ø 10 mm	in slang

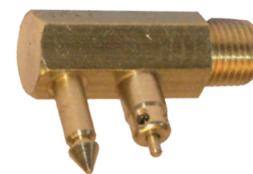

Artikel	Omschrijving	Aansluitzijde
108954	JOHNSON / EVINRUDE (Op deze stekker past stekker 108931)	tank

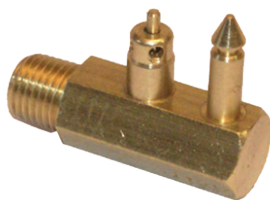

Artikel	Omschrijving	Aansluitzijde
108955	YAMAHA, MARINER, MERCURY (Op deze stekker past stekker 108941)	in slang

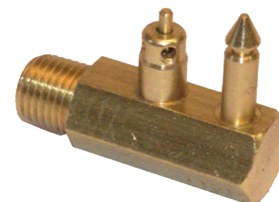

Artikel	Omschrijving	Aansluitzijde
108952	MERCURY Nieuw Model (Op deze stekker past stekker 108956)	tank



Artikel	Omschrijving	Aansluitzijde
108935	YAMAHA, MARINER, MERCURY (Op deze stekker past stekker 108941)	tank

Excellent
Watersport

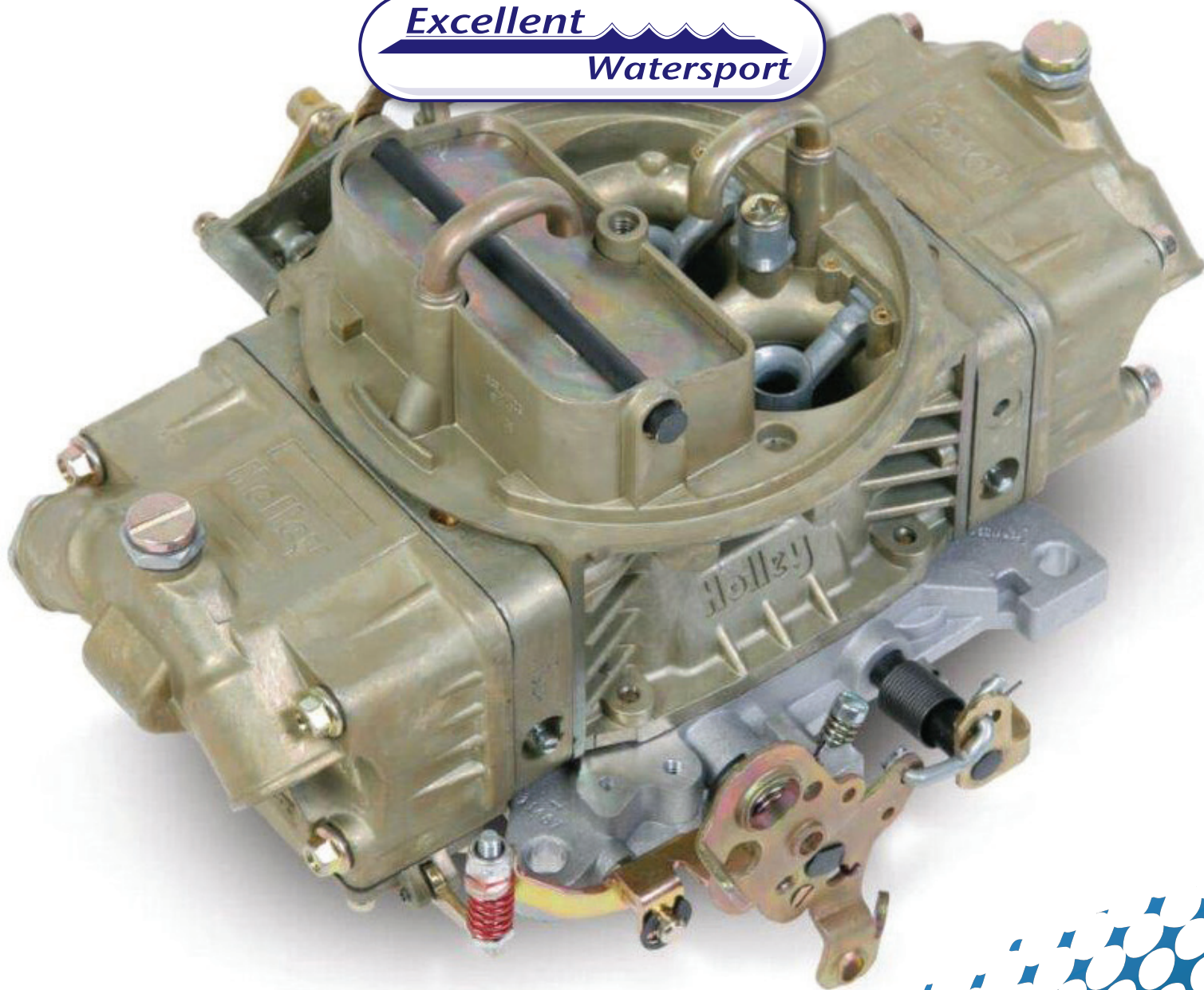

*Wij houden de
vaart er in!*